

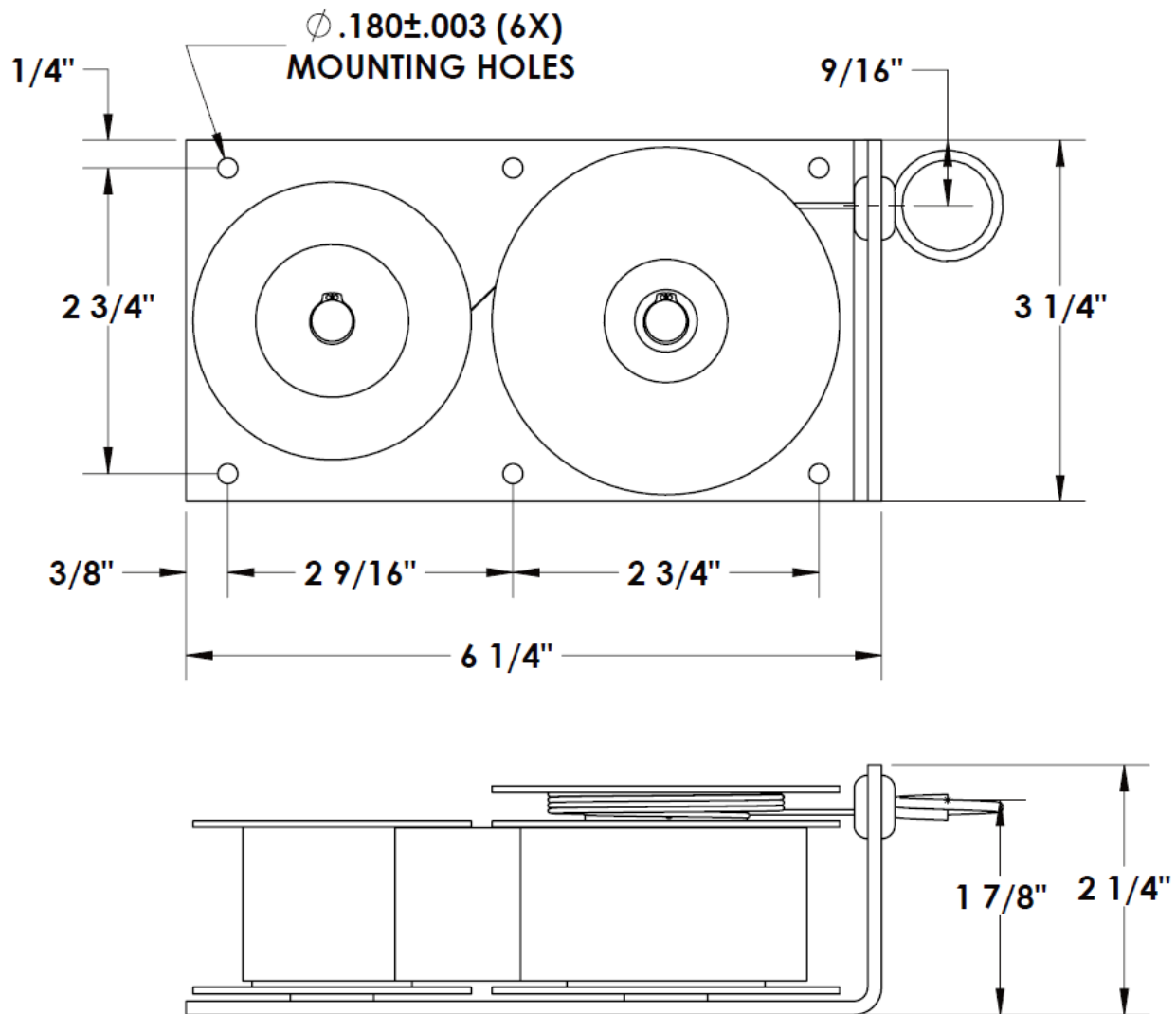

PART NUMBER	ML-2490
SPEC NUMBER	193275
DESCRIPTION	NEG'ATOR Motor Assembly
SPRING	TYPE 301 HI-YIELD STAINLESS STEEL
CABLE	.031" DIA 3X7 HI-YIELD GALV STEEL AIRCRAFT CABLE COATED TO .047" DIA WITH NYLON
BASE	COLD ROLLED STEEL-ZINC-PLATED
DRUMS	CELCON



SPRING TORQUE (LB-IN)	5.62
CABLE TENSION (LBS)	5
CABLE LENGTH (IN)	235
REVOLUTIONS	40
ENDURANCE (MIN CYCLE)	9000

DRAWING FOR REFERENCE ONLY