

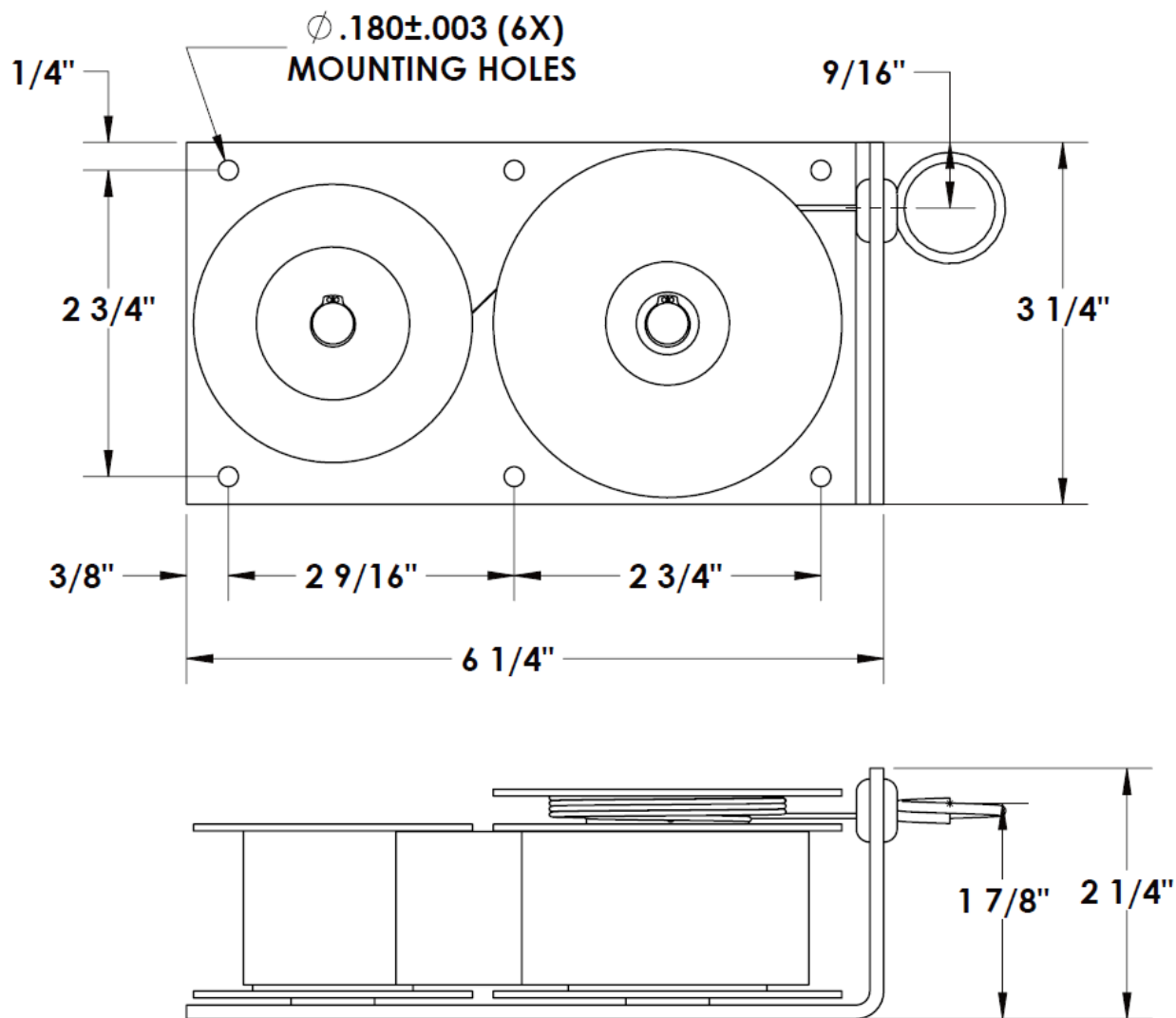

PART NUMBER	ML-2492
SPEC NUMBER	193280
DESCRIPTION	NEG'ATOR Motor Assembly
SPRING	TYPE 301 HI-YIELD STAINLESS STEEL
CABLE	.031" DIA 3X7 HI-YIELD GALV STEEL AIRCRAFT CABLE COATED TO .047" DIA WITH NYLON
BASE	COLD ROLLED STEEL-ZINC-PLATED
DRUMS	CELCON



SPRING TORQUE (LB-IN)	3.63
CABLE TENSION (LBS)	3.1
CABLE LENGTH (IN)	273
REVOLUTIONS	45
ENDURANCE (MIN CYCLE)	15000

DRAWING FOR REFERENCE ONLY