

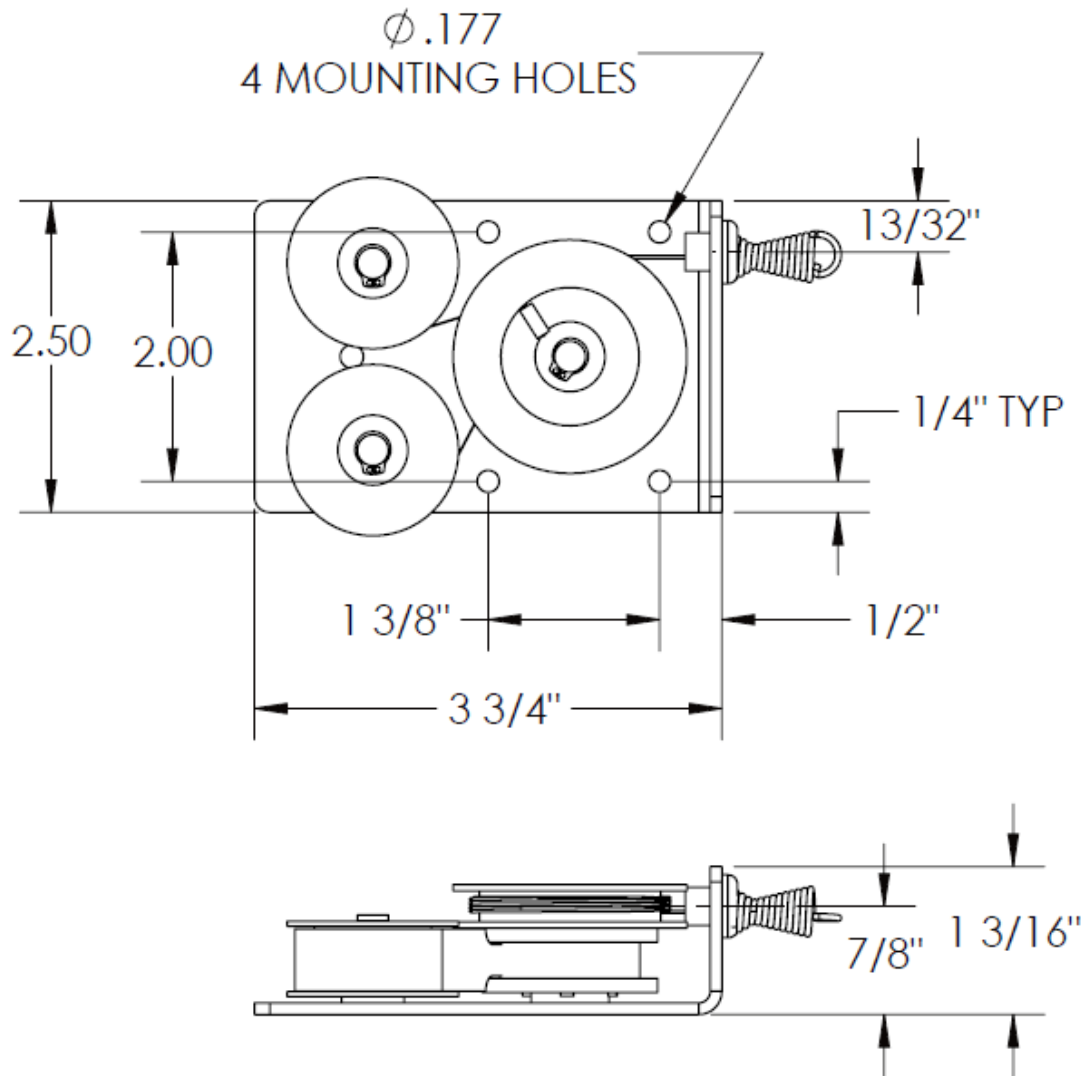

PART NUMBER	ML-2920
SPEC NUMBER	196580
DESCRIPTION	NEG'ATOR Motor Assembly
SPRING	TYPE 301 HI-YIELD STAINLESS STEEL
CABLE	.024" DIA UNCOATED STAINLESS STEEL
BASE	ZINC-PLATED
DRUMS	CELCON OR NYLON



SPRING TORQUE (LB-IN)	3.12
CABLE TENSION (LBS)	4
CABLE LENGTH (IN)	72
REVOLUTIONS	15
ENDURANCE (MIN CYCLE)	2500

DRAWING FOR REFERENCE ONLY